

Creative Commons Attribution 4.0 International license. CC-BY-4.0

PCB 76.2 x 76.2 mm, M3 mounting holes

Marten Electric by Martin Niec; www.martenelectric.cz; martenelectric@gmail.com

Sheet:

File: z80_cpu_tester.kicad_pcb

Title: Z80 CPU NOP TESTER

Size: A4 Date: 2022-08-19

KiCad E.D.A. kicad (6.0.4)

Rev: v1.21

Id: 1/1

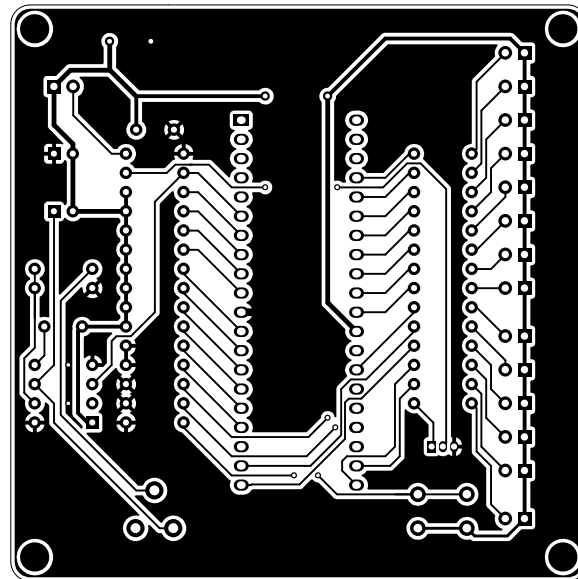

Creative Commons Attribution 4.0 International license. CC-BY-4.0

PCB 76.2 x 76.2 mm, M3 mounting holes

Marten Electric by Martin Niec; www.martenelectric.cz; martenelectric@gmail.com

Sheet:

File: z80_cpu_tester.kicad_pcb

Title: Z80 CPU NOP TESTER

Size: A4 Date: 2022-08-19

Rev: v1.21

KiCad E.D.A. kicad (6.0.4)

Id: 1/1

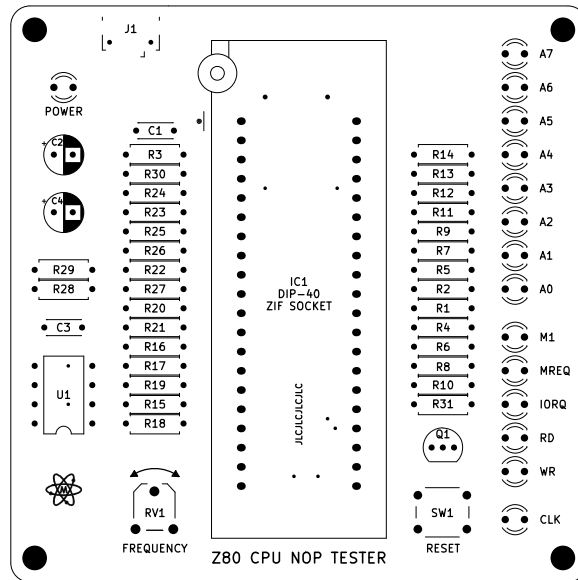

Creative Commons Attribution 4.0 International license. CC-BY-4.0

PCB 76.2 x 76.2 mm, M3 mounting holes

Marten Electric by Martin Niec; www.martenelectric.cz; martenelectric@gmail.com

Sheet:

File: z80_cpu_tester.kicad_pcb

Title: Z80 CPU NOP TESTER

Size: A4 Date: 2022-08-19

Rev: v1.21

KiCad E.D.A. kicad (6.0.4)

Id: 1/1

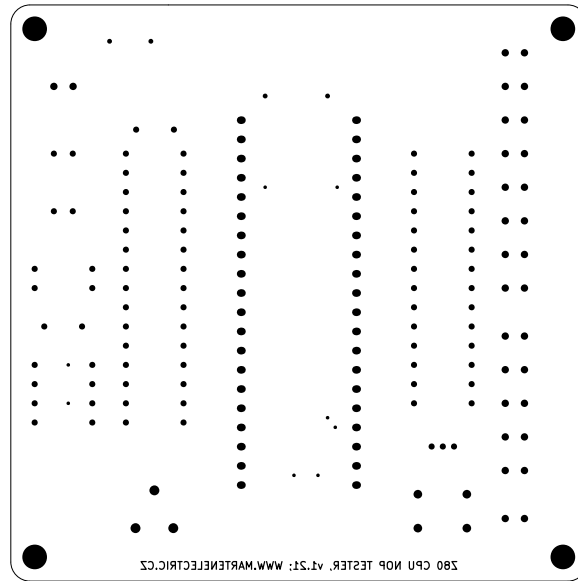

Creative Commons Attribution 4.0 International license. CC-BY-4.0

PCB 76.2 x 76.2 mm, M3 mounting holes

Marten Electric by Martin Niec; www.martenelectric.cz; martenelectric@gmail.com

Sheet:

File: z80_cpu_tester.kicad_pcb

Title: Z80 CPU NOP TESTER

Size: A4 Date: 2022-08-19

KiCad E.D.A. kicad (6.0.4)

Rev: v1.21

Id: 1/1

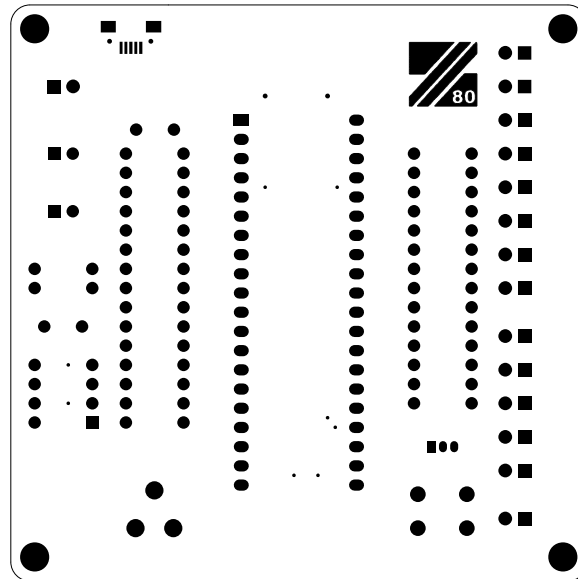

Creative Commons Attribution 4.0 International license. CC-BY-4.0

PCB 76.2 x 76.2 mm, M3 mounting holes

Marten Electric by Martin Niec; www.martenelectric.cz; martenelectric@gmail.com

Sheet:

File: z80_cpu_tester.kicad_pcb

Title: Z80 CPU NOP TESTER

Size: A4 Date: 2022-08-19

KiCad E.D.A. kicad (6.0.4)

Rev: v1.21

Id: 1/1

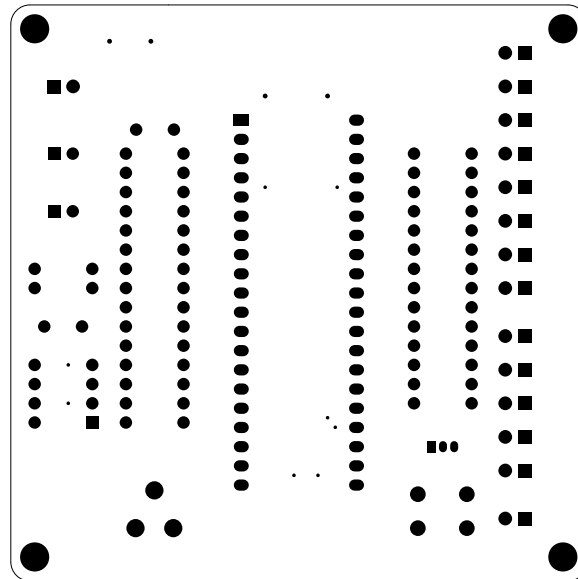

Creative Commons Attribution 4.0 International license. CC-BY-4.0

PCB 76.2 x 76.2 mm, M3 mounting holes

Marten Electric by Martin Niec; www.martenelectric.cz; martenelectric@gmail.com

Sheet:

File: z80_cpu_tester.kicad_pcb

Title: Z80 CPU NOP TESTER

Size: A4 Date: 2022-08-19

KiCad E.D.A. kicad (6.0.4)

Rev: v1.21

Id: 1/1

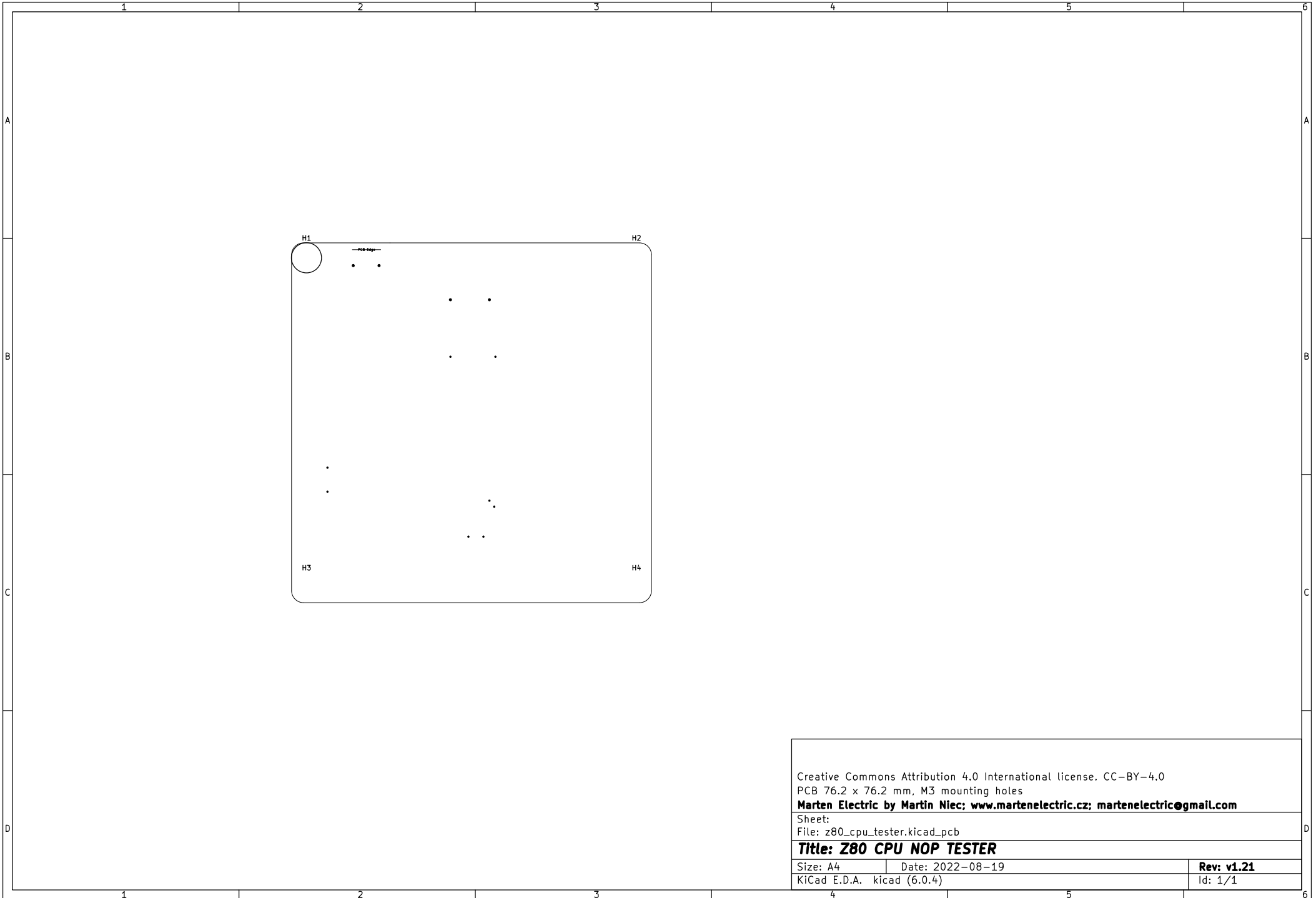

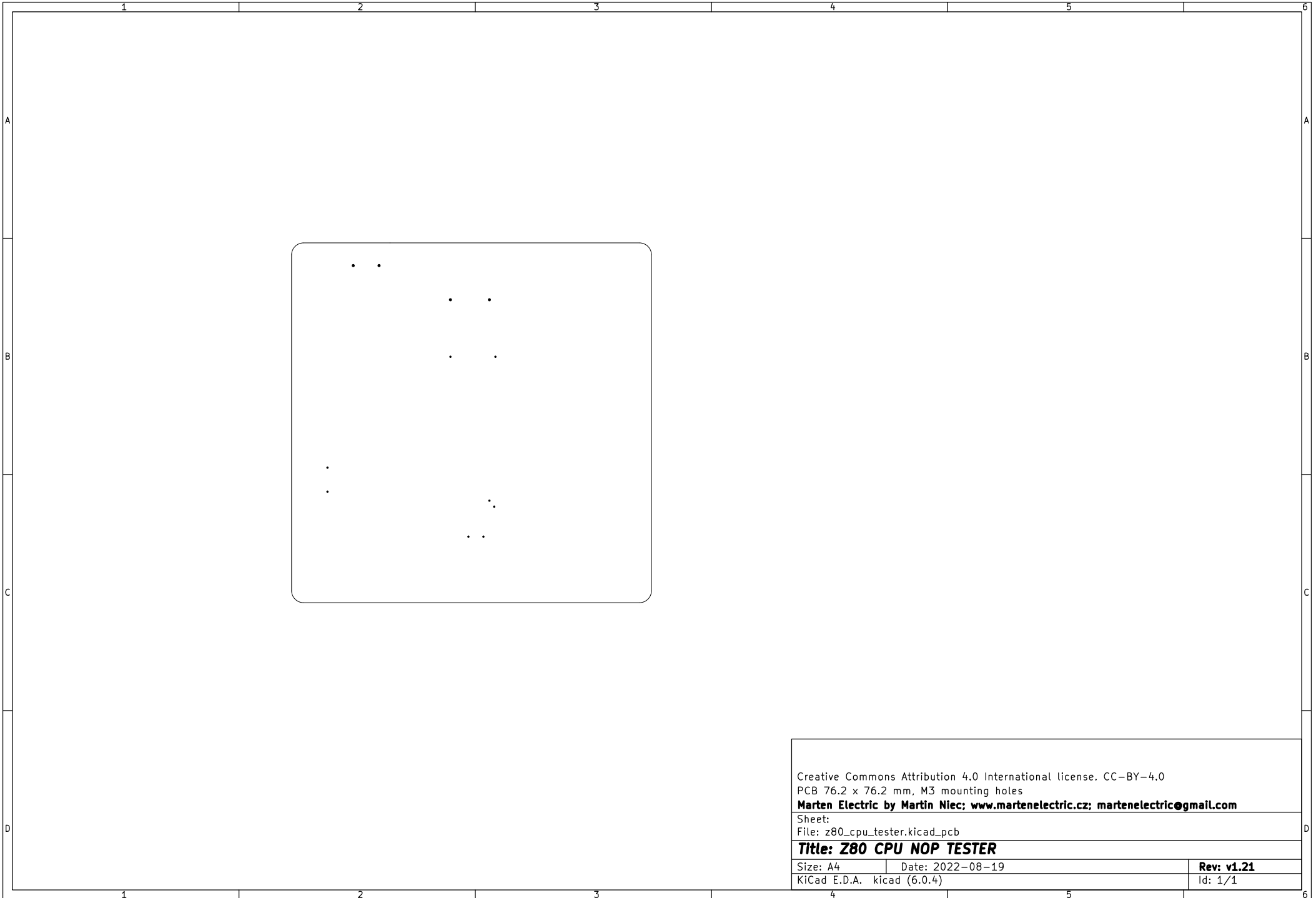

Creative Commons Attribution 4.0 International license. CC-BY-4.0

PCB 76.2 x 76.2 mm, M3 mounting holes

Marten Electric by Martin Niec; www.martenelectric.cz; martenelectric@gmail.com

Sheet:

File: z80_cpu_tester.kicad_pcb

Title: Z80 CPU NOP TESTER

Size: A4 Date: 2022-08-19

Rev: v1.21

KiCad E.D.A. kicad (6.0.4)

Id: 1/1

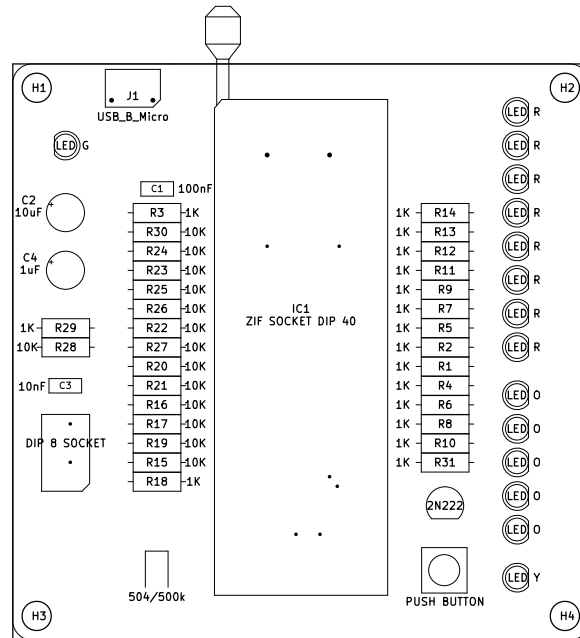

Creative Commons Attribution 4.0 International license. CC-BY-4.0

PCB 76.2 x 76.2 mm, M3 mounting holes

Marten Electric by Martin Niec; www.martenelectric.cz; martenelectric@gmail.com

Sheet:

File: z80_cpu_tester.kicad_pcb

Title: Z80 CPU NOP TESTER

Size: A4 Date: 2022-08-19

Rev: v1.21

KiCad E.D.A. kicad (6.0.4)

Id: 1/1